

# MOSFET – N-Channel, QFET

800 V, 3.0 A, 4.8 mΩ

## FQP3N80C, FQPF3N80C

### Description

This N-Channel enhancement mode power MOSFET is produced using onsemi's proprietary planar stripe and DMOS technology. This advanced MOSFET technology has been especially tailored to reduce on-state resistance, and to provide superior switching performance and high avalanche energy strength. These devices are suitable for switched mode power supplies, active power factor correction (PFC), and electronic lamp ballasts.

### Features

- 3.0 A, 800 V,  $R_{DS(on)} = 4.8 \Omega$  (Max.) @  $V_{GS} = 10$  V,  $I_D = 1.5$  A
- Low Gate Charge (Typ. 13 nC)
- Low  $C_{rss}$  (Typ. 5.5 pF)
- 100% Avalanche Tested

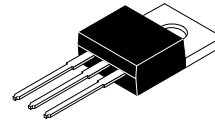

TO-220-3LD  
CASE 340AT

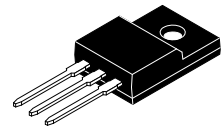

TO-220 Fullpack,  
3-Lead /  
TO-220F-3SG  
CASE 221AT

### N-CHANNEL MOSFET

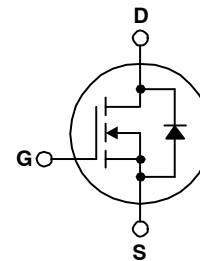

### MARKING DIAGRAM

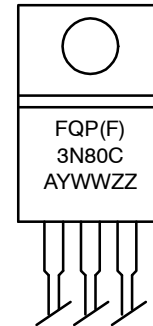

FQP(F)3N80C = Specific Device Code  
 A = Assembly Location  
 YWW = Date Code (Year & Week)  
 ZZ = Assembly Lot

### ORDERING INFORMATION

Device	Package	Shipping
FQP3N80C	TO-220-3LD	1,000 Units / Tube
FQPF3N80C	TO-220 Fullpack	1,000 Units / Tube

# FQP3N80C, FQPF3N80C

## MOSFET MAXIMUM RATINGS ( $T_C = 25^\circ\text{C}$ unless otherwise noted)

Symbol	Parameter	FQP3N80C	FQPF3N80C	Unit	
$V_{DSS}$	Drain-Source Voltage	800	800	V	
$I_D$	Drain Current	- Continuous ( $T_C = 25^\circ\text{C}$ )	3*	A	
		- Continuous ( $T_C = 100^\circ\text{C}$ )	1.9*	A	
$I_{DM}$	Drain Current	12	12*	A	
$V_{GSS}$	Gate-Source Voltage	$\pm 30$	$\pm 30$	V	
$E_{AS}$	Single Pulsed Avalanche Energy (Note 2)	320	320	mJ	
$I_{AR}$	Avalanche Current (Note 1)	3	3	A	
$E_{AR}$	Repetitive Avalanche Energy (Note 1)	10.7	10.7	mJ	
dv/dt	Peak Diode Recovery dv/dt (Note 3)	4.5	4.5	V/ns	
$P_D$	Power Dissipation	( $T_C = 25^\circ\text{C}$ )	107	39	W
		- Derate Above $25^\circ\text{C}$	0.85	0.31	W/ $^\circ\text{C}$
$T_J, T_{STG}$	Operating and Storage Temperature Range	-55 to +150	-55 to +150	$^\circ\text{C}$	
$T_L$	Maximum Lead Temperature for Soldering, 1/8" from Case for 5 Seconds	300	300	$^\circ\text{C}$	

Stresses exceeding those listed in the Maximum Ratings table may damage the device. If any of these limits are exceeded, device functionality should not be assumed, damage may occur and reliability may be affected.

## THERMAL CHARACTERISTICS

Symbol	Parameter	FQP3N80C	FQPF3N80C	Unit
$R_{\theta JC}$	Thermal Resistance, Junction-to-Case, Max.	1.17	3.2	$^\circ\text{C}/\text{W}$
$R_{\theta JA}$	Thermal Resistance, Junction-to-Ambient, Max.	62.5	62.5	$^\circ\text{C}/\text{W}$

## ELECTRICAL CHARACTERISTICS ( $T_C = 25^\circ\text{C}$ unless otherwise noted)

Symbol	Parameter	Conditions	Min	Typ	Max	Unit
--------	-----------	------------	-----	-----	-----	------

### OFF CHARACTERISTICS

$BV_{DSS}$	Drain-Source Breakdown Voltage	$V_{GS} = 0\text{ V}, I_D = 250\ \mu\text{A}$	800	-	-	V
$\Delta BV_{DSS} / \Delta T_J$	Breakdown Voltage Temperature Coefficient	$I_D = 250\ \mu\text{A}$ , Referenced to $25^\circ\text{C}$	-	1	-	V/ $^\circ\text{C}$
$I_{DSS}$	Zero Gate Voltage Drain Current	$V_{DS} = 800\text{ V}, V_{GS} = 0\text{ V}$ $V_{DS} = 640\text{ V}, T_C = 125^\circ\text{C}$	-	-	10	$\mu\text{A}$
			-	-	100	$\mu\text{A}$
$I_{GSSF}$	Gate-Body Leakage Current, Forward	$V_{GS} = 30\text{ V}, V_{DS} = 0\text{ V}$	-	-	100	nA
$I_{GSSR}$	Gate-Body Leakage Current, Reverse	$V_{GS} = -30\text{ V}, V_{DS} = 0\text{ V}$	-	-	-100	nA

### ON CHARACTERISTICS

$V_{GS(th)}$	Gate Threshold Voltage	$V_{DS} = V_{GS}, I_D = 250\ \mu\text{A}$	3.0	-	5.0	V
$R_{DS(on)}$	Static Drain-Source On-Resistance	$V_{GS} = 10\text{ V}, I_D = 1.5\text{ A}$	-	4.0	4.8	$\Omega$
$g_{FS}$	Forward Transconductance	$V_{DS} = 50\text{ V}, I_D = 1.5\text{ A}$	-	3	-	S

### DYNAMIC CHARACTERISTICS

$C_{iss}$	Input Capacitance	$V_{DS} = 25\text{ V}, V_{GS} = 0\text{ V}, f = 1.0\text{ MHz}$	-	543	705	pF
$C_{oss}$	Output Capacitance		-	54	70	pF
$C_{rss}$	Reverse Transfer Capacitance		-	5.5	7.5	pF

# FQP3N80C, FQPF3N80C

## ELECTRICAL CHARACTERISTICS ( $T_C = 25^\circ\text{C}$ unless otherwise noted)(continued)

Symbol	Parameter	Conditions	Min	Typ	Max	Unit
--------	-----------	------------	-----	-----	-----	------

### SWITCHING CHARACTERISTICS

$t_{d(on)}$	Turn-On Delay Time	$V_{DD} = 400\text{ V}$ , $I_D = 3\text{ A}$ , $R_G = 25\ \Omega$ (Note 4)	–	15	40	ns
$t_r$	Turn-On Rise Time		–	43.5	95	ns
$t_{d(off)}$	Turn-Off Delay Time		–	22.5	55	ns
$t_f$	Turn-Off Fall Time		–	32	75	ns
$Q_g$	Total Gate Charge	$V_{DS} = 640\text{ V}$ , $I_D = 3\text{ A}$ , $V_{GS} = 10\text{ V}$ (Note 4)	–	13	16.5	nC
$Q_{gs}$	Gate-Source Charge		–	3.4	–	nC
$Q_{gd}$	Gate-Drain Charge		–	5.8	–	nC

### DRAIN-SOURCE DIODE CHARACTERISTICS AND MAXIMUM RATINGS

$I_S$	Maximum Continuous Drain-Source Diode Forward Current		–	–	3.0	A
$I_{SM}$	Maximum Pulsed Drain-Source Diode Forward Current		–	–	12	A
$V_{SD}$	Drain-Source Diode Forward Voltage	$V_{GS} = 0\text{ V}$ , $I_S = 3.0\text{ A}$	–	–	1.4	V
$t_{rr}$	Reverse Recovery Time	$V_{GS} = 0\text{ V}$ , $I_S = 3.0\text{ A}$ , $di_F/dt = 100\text{ A}/\mu\text{s}$	–	642	–	ns
$Q_{rr}$	Reverse Recovery Charge		–	4.0	–	$\mu\text{C}$

Product parametric performance is indicated in the Electrical Characteristics for the listed test conditions, unless otherwise noted. Product performance may not be indicated by the Electrical Characteristics if operated under different conditions.

1. Repetitive rating; pulse-width limited by maximum junction temperature.
2.  $L = 67\text{ mH}$ ,  $I_{AS} = 3.0\text{ A}$ ,  $V_{DD} = 50\text{ V}$ ,  $R_G = 25\ \Omega$ , starting  $T_J = 25^\circ\text{C}$ .
3.  $I_{SD} \leq 3\text{ A}$ ,  $di/dt \leq 200\text{ A}/\mu\text{s}$ ,  $V_{DD} \leq BV_{DSS}$ , starting  $T_J = 25^\circ\text{C}$ .
4. Essentially independent of operating temperature.

# FQP3N80C, FQPF3N80C

## TYPICAL CHARACTERISTICS

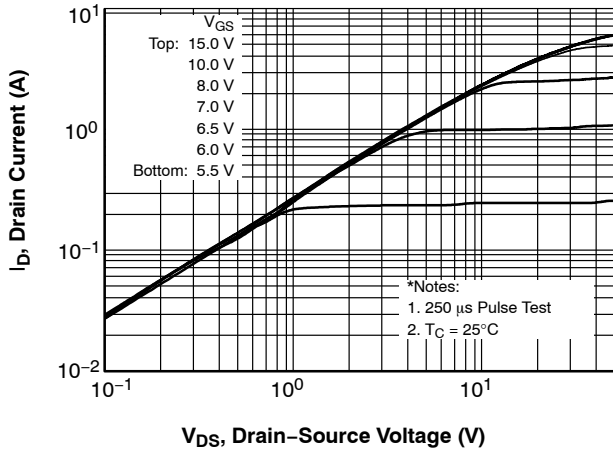

Figure 1. On-Region Characteristics

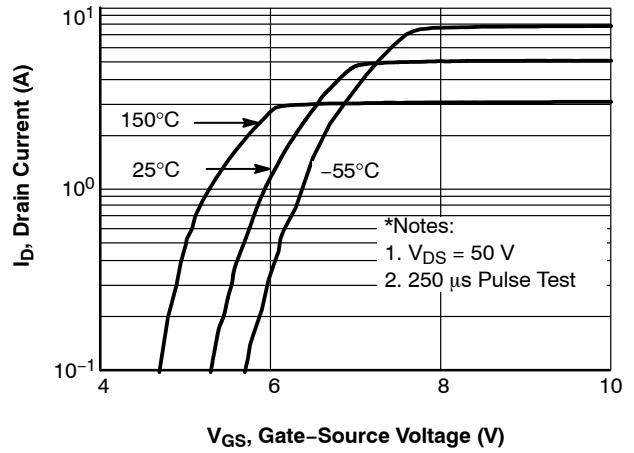

Figure 2. Transfer Characteristics

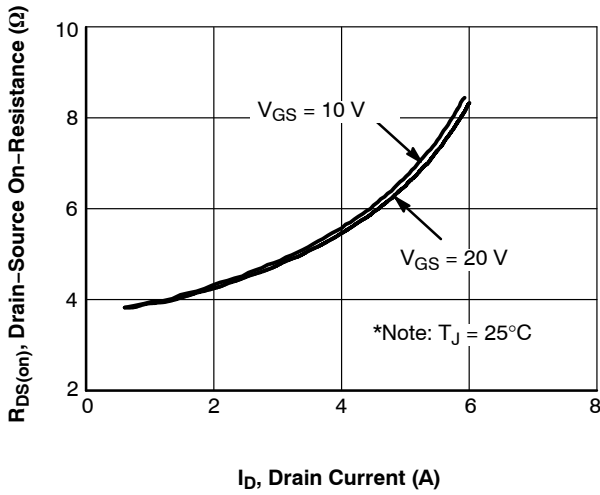

Figure 3. On-Resistance Variation vs. Drain Current and Gate Voltage

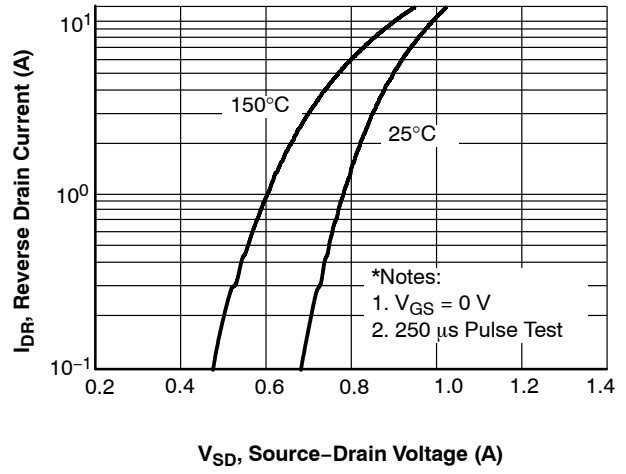

Figure 4. Body Diode Forward Voltage Variation with Source Current and Temperature

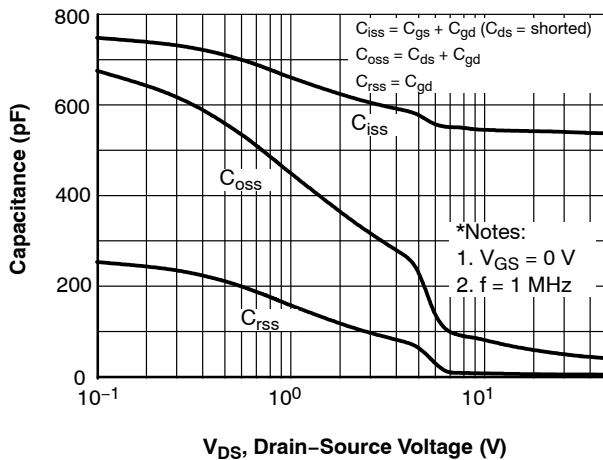

Figure 5. Capacitance Characteristics

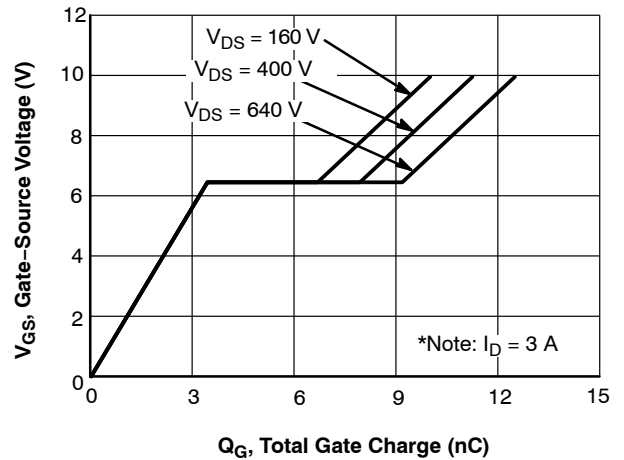
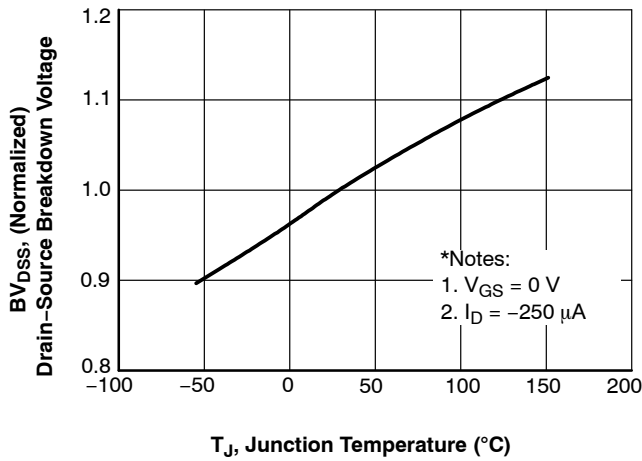

Figure 6. Gate Charge Characteristics

# FQP3N80C, FQPF3N80C

## TYPICAL CHARACTERISTICS (continued)



**Figure 7. Breakdown Voltage Variation vs. Temperature**

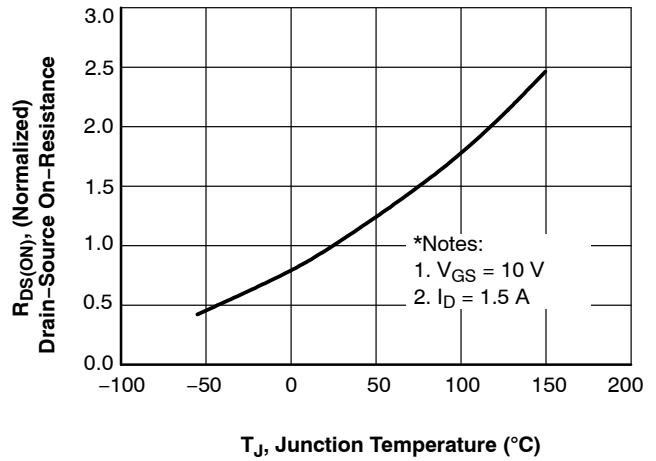

**Figure 8. On-Resistance Variation vs. Temperature**

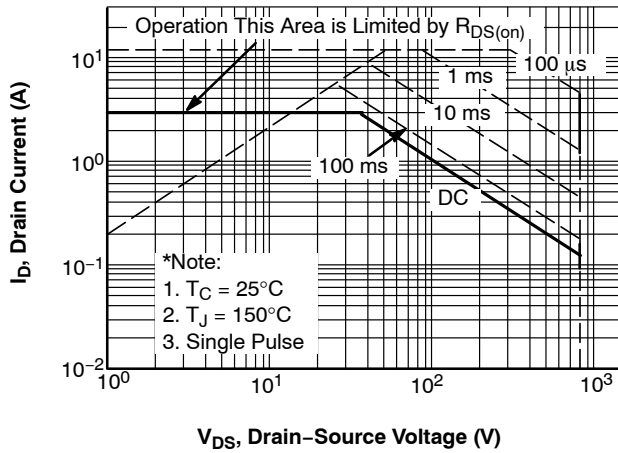

**Figure 9. Maximum Safe Operating Area for FQP3N80C**

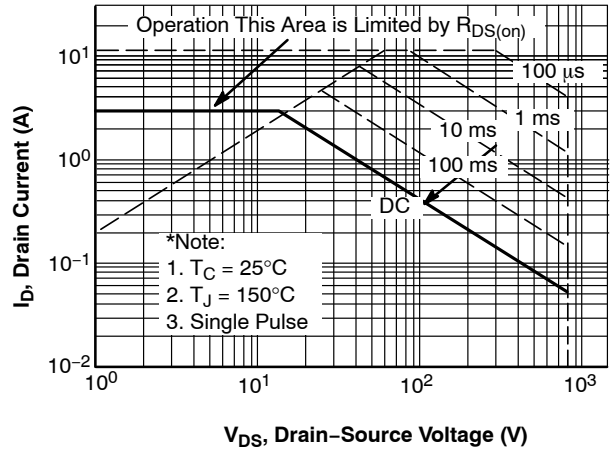

**Figure 10. Maximum Safe Operating Area for FQPF3N80C**

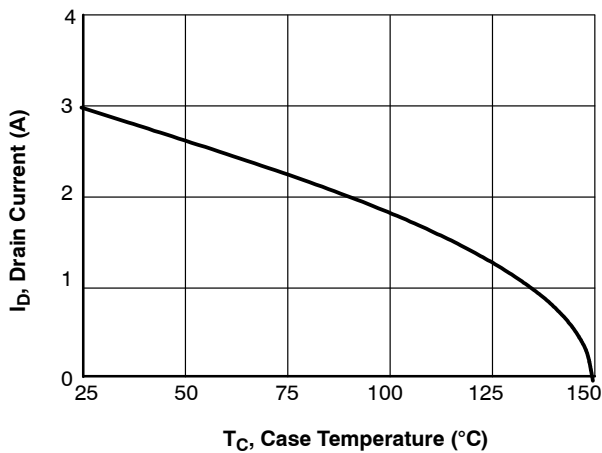

**Figure 11. Maximum Drain Current vs. Case Temperature**

# FQP3N80C, FQPF3N80C

## TYPICAL CHARACTERISTICS (continued)

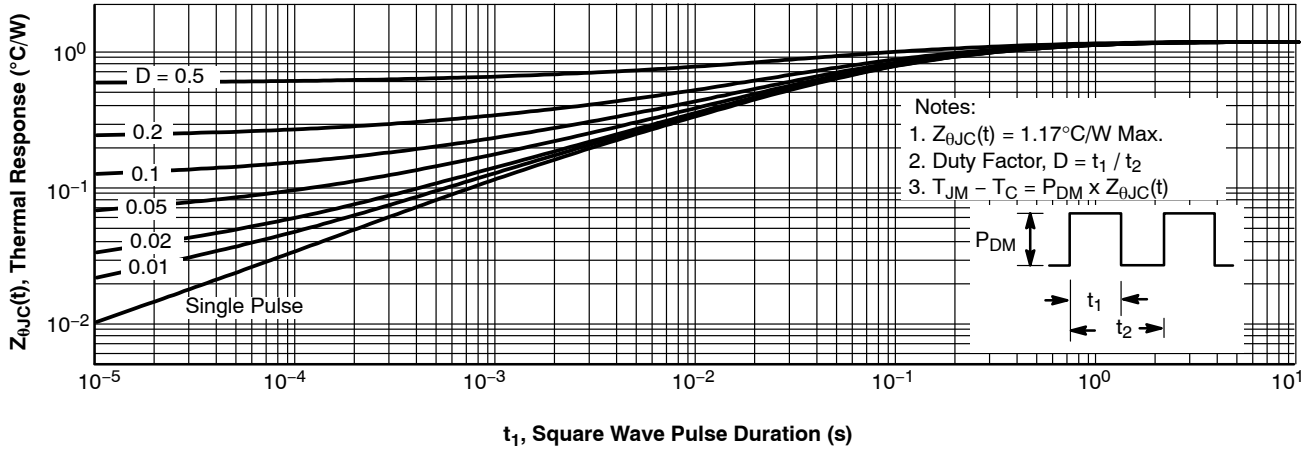

Figure 12. Transient Thermal Response Curve for FQP3N80C

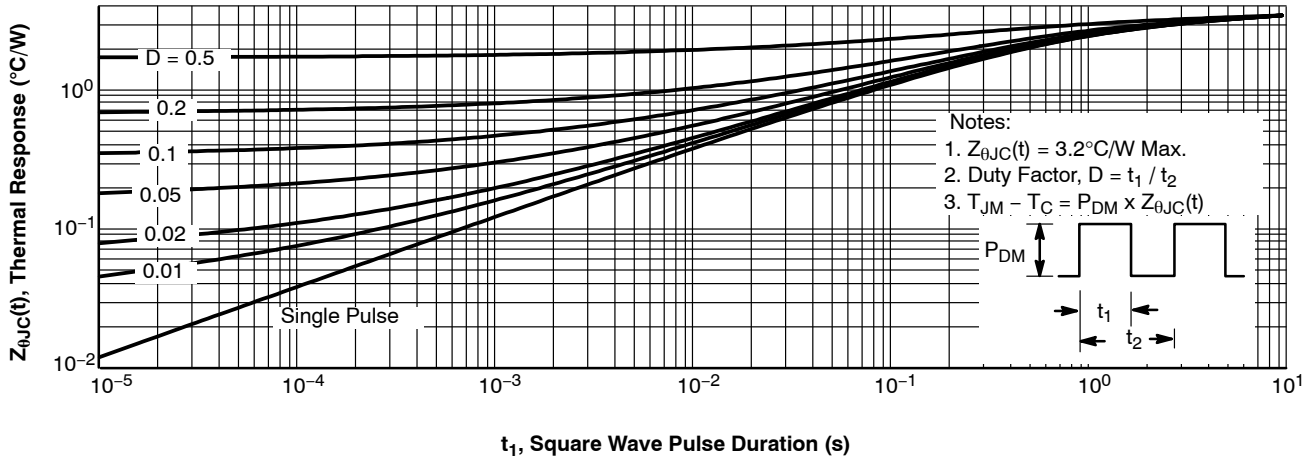
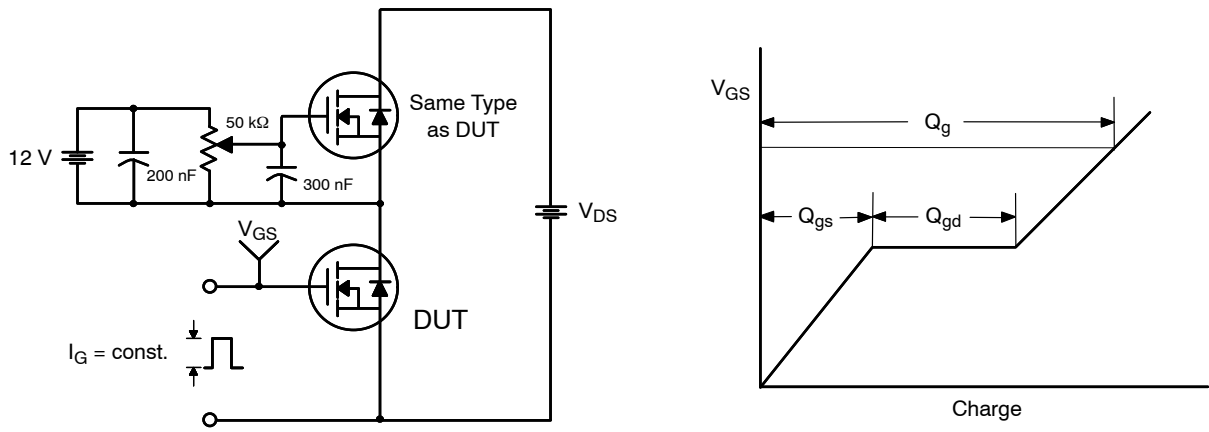
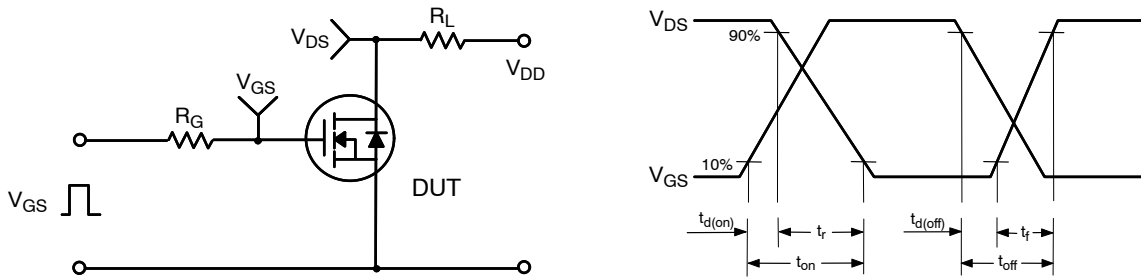

Figure 13. Transient Thermal Response Curve for FQPF3N80C

## FQP3N80C, FQPF3N80C



**Figure 14. Gate Charge Test Circuit & Waveform**



**Figure 15. Resistive Switching Test Circuit & Waveforms**

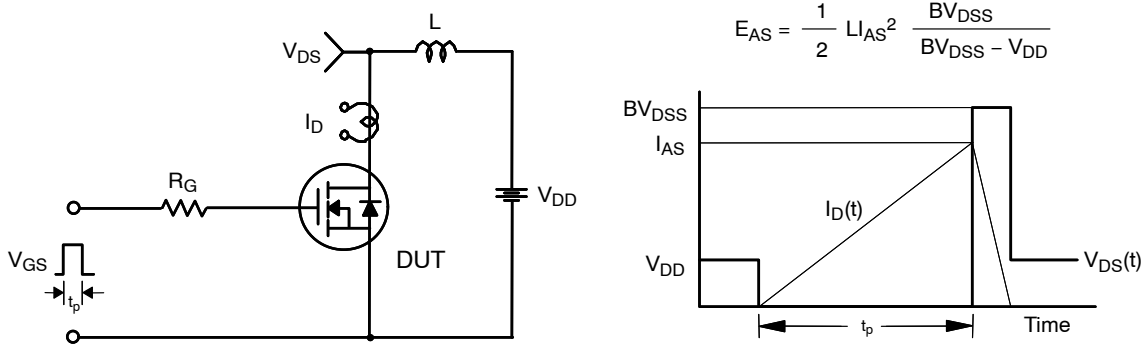

**Figure 16. Unclamped Inductive Switching Test Circuit & Waveforms**

# FQP3N80C, FQPF3N80C

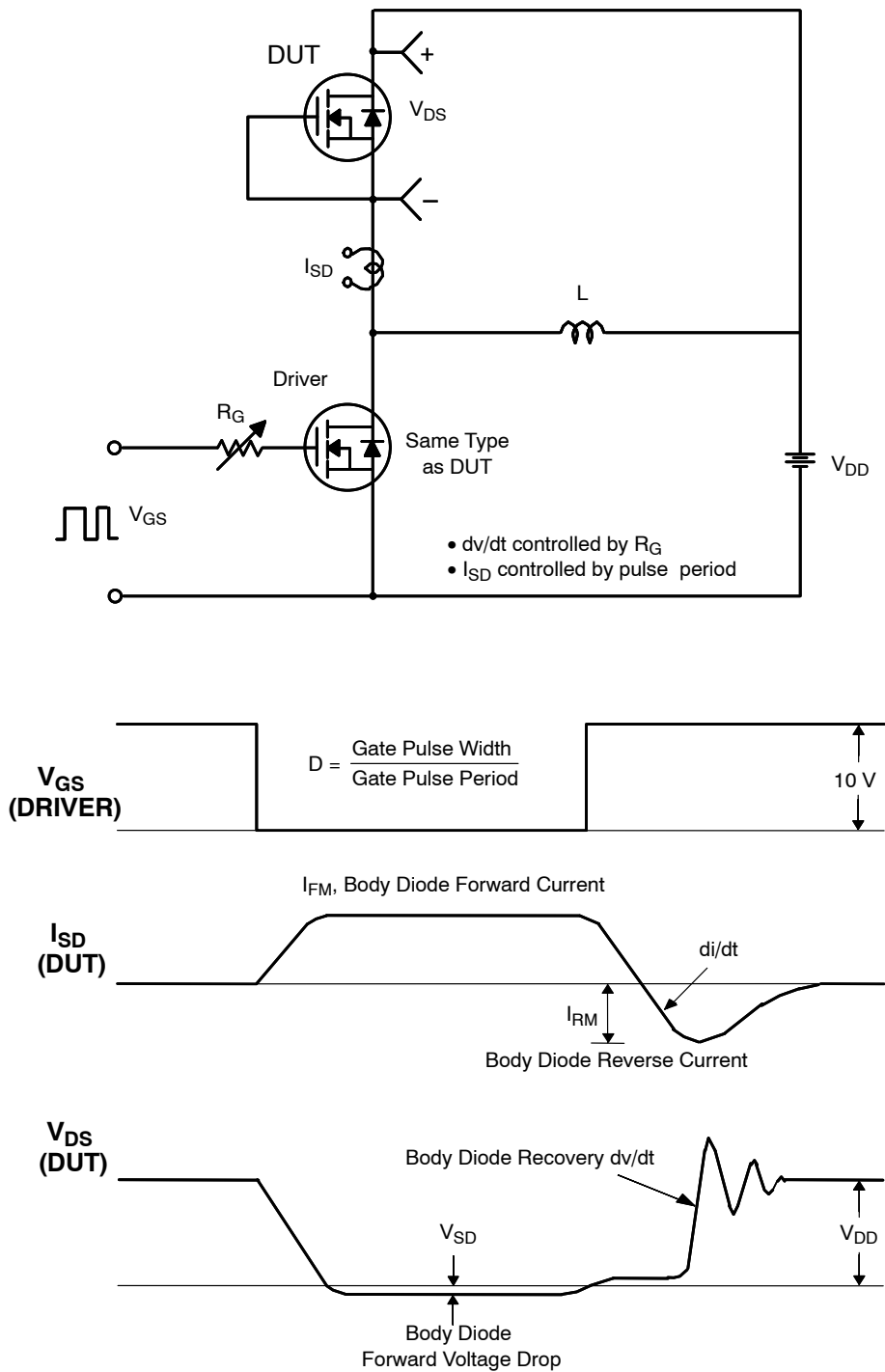

Figure 17. Peak Diode Recovery  $dv/dt$  Test Circuit & Waveforms



# MECHANICAL CASE OUTLINE

## PACKAGE DIMENSIONS

ON Semiconductor®



### TO-220 Fullpack, 3-Lead / TO-220F-3SG CASE 221AT ISSUE B

DATE 19 JAN 2021



Scale 1:1

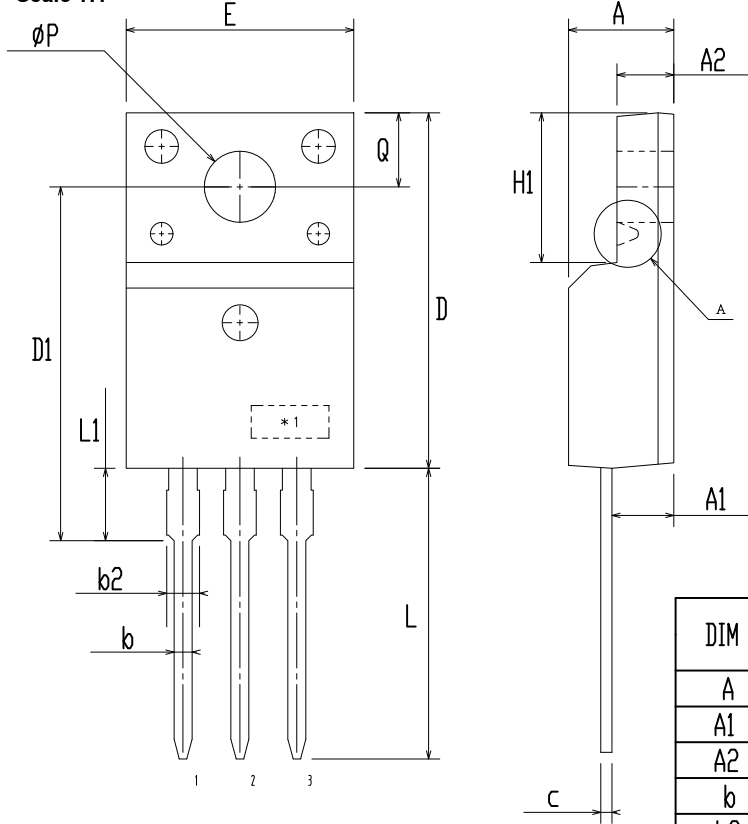

DIM	MILLIMETERS		
	MIN	NOM	MAX
A	4.50	4.70	4.90
A1	2.56	2.76	2.96
A2	2.34	2.54	2.74
b	0.70	0.80	0.90
b2	~	~	1.47
c	0.45	0.50	0.60
D	15.67	15.87	16.07
D1	15.60	15.80	16.00
E	9.96	10.16	10.36
e	2.34	2.54	2.74
F	~	0.84	~
H1	6.48	6.68	6.88
L	12.78	12.98	13.18
L1	3.03	3.23	3.43
phi P	2.98	3.18	3.38
phi P1	~	1.00	~
Q	3.20	3.30	3.40

**NOTES:**

- A. DIMENSION AND TOLERANCE AS ASME Y14.5-2009
- B. DIMENSIONS ARE EXCLUSIVE OF BURRS, MOLD FLASH AND TIE BAR PROTRUCTIONS.
- C. OPTION 1 - WITH SUPPORT PIN HOLE  
OPTION 2 - NO SUPPORT PIN HOLE

<b>DOCUMENT NUMBER:</b>	<b>98AON67439E</b>	Electronic versions are uncontrolled except when accessed directly from the Document Repository. Printed versions are uncontrolled except when stamped "CONTROLLED COPY" in red.
<b>DESCRIPTION:</b>	<b>TO-220 FULLPACK, 3-LEAD / TO-220F-3SG</b>	<b>PAGE 1 OF 1</b>

ON Semiconductor and are trademarks of Semiconductor Components Industries, LLC dba ON Semiconductor or its subsidiaries in the United States and/or other countries. ON Semiconductor reserves the right to make changes without further notice to any products herein. ON Semiconductor makes no warranty, representation or guarantee regarding the suitability of its products for any particular purpose, nor does ON Semiconductor assume any liability arising out of the application or use of any product or circuit, and specifically disclaims any and all liability, including without limitation special, consequential or incidental damages. ON Semiconductor does not convey any license under its patent rights nor the rights of others.

# MECHANICAL CASE OUTLINE

## PACKAGE DIMENSIONS

ON Semiconductor®



Scale 1:1

### TO-220-3LD CASE 340AT ISSUE A

DATE 03 OCT 2017



- NOTES:
- A) REFERENCE JEDEC, TO-220, VARIATION AB
  - B) ALL DIMENSIONS ARE IN MILLIMETERS.
  - C) DIMENSIONS COMMON TO ALL PACKAGE SUPPLIERS EXCEPT WHERE NOTED [ ].
  - D) LOCATION OF MOLDED FEATURE MAY VARY (LOWER LEFT CORNER, LOWER CENTER AND CENTER OF THE PACKAGE)
  - E) DOES NOT COMPLY JEDEC STANDARD VALUE.
  - F) "A1" DIMENSIONS AS BELOW:  
 SINGLE GAUGE = 0.51 - 0.61  
 DUAL GAUGE = 1.10 - 1.45
  - G) PRESENCE IS SUPPLIER DEPENDENT
  - H) SUPPLIER DEPENDENT MOLD LOCKING HOLES IN HEATSINK.

<b>DOCUMENT NUMBER:</b>	<b>98AON13818G</b>	Electronic versions are uncontrolled except when accessed directly from the Document Repository. Printed versions are uncontrolled except when stamped "CONTROLLED COPY" in red.
<b>DESCRIPTION:</b>	<b>TO-220-3LD</b>	<b>PAGE 1 OF 1</b>

ON Semiconductor and ON are trademarks of Semiconductor Components Industries, LLC dba ON Semiconductor or its subsidiaries in the United States and/or other countries. ON Semiconductor reserves the right to make changes without further notice to any products herein. ON Semiconductor makes no warranty, representation or guarantee regarding the suitability of its products for any particular purpose, nor does ON Semiconductor assume any liability arising out of the application or use of any product or circuit, and specifically disclaims any and all liability, including without limitation special, consequential or incidental damages. ON Semiconductor does not convey any license under its patent rights nor the rights of others.

**onsemi**, **Onsemi**, and other names, marks, and brands are registered and/or common law trademarks of Semiconductor Components Industries, LLC dba "**onsemi**" or its affiliates and/or subsidiaries in the United States and/or other countries. **onsemi** owns the rights to a number of patents, trademarks, copyrights, trade secrets, and other intellectual property. A listing of **onsemi**'s product/patent coverage may be accessed at [www.onsemi.com/site/pdf/Patent-Marking.pdf](http://www.onsemi.com/site/pdf/Patent-Marking.pdf). **onsemi** reserves the right to make changes at any time to any products or information herein, without notice. The information herein is provided "as-is" and **onsemi** makes no warranty, representation or guarantee regarding the accuracy of the information, product features, availability, functionality, or suitability of its products for any particular purpose, nor does **onsemi** assume any liability arising out of the application or use of any product or circuit, and specifically disclaims any and all liability, including without limitation special, consequential or incidental damages. Buyer is responsible for its products and applications using **onsemi** products, including compliance with all laws, regulations and safety requirements or standards, regardless of any support or applications information provided by **onsemi**. "Typical" parameters which may be provided in **onsemi** data sheets and/or specifications can and do vary in different applications and actual performance may vary over time. All operating parameters, including "Typicals" must be validated for each customer application by customer's technical experts. **onsemi** does not convey any license under any of its intellectual property rights nor the rights of others. **onsemi** products are not designed, intended, or authorized for use as a critical component in life support systems or any FDA Class 3 medical devices or medical devices with a same or similar classification in a foreign jurisdiction or any devices intended for implantation in the human body. Should Buyer purchase or use **onsemi** products for any such unintended or unauthorized application, Buyer shall indemnify and hold **onsemi** and its officers, employees, subsidiaries, affiliates, and distributors harmless against all claims, costs, damages, and expenses, and reasonable attorney fees arising out of, directly or indirectly, any claim of personal injury or death associated with such unintended or unauthorized use, even if such claim alleges that **onsemi** was negligent regarding the design or manufacture of the part. **onsemi** is an Equal Opportunity/Affirmative Action Employer. This literature is subject to all applicable copyright laws and is not for resale in any manner.

---

## ADDITIONAL INFORMATION

### TECHNICAL PUBLICATIONS:

Technical Library: [www.onsemi.com/design/resources/technical-documentation](http://www.onsemi.com/design/resources/technical-documentation)  
onsemi Website: [www.onsemi.com](http://www.onsemi.com)

### ONLINE SUPPORT: [www.onsemi.com/support](http://www.onsemi.com/support)

For additional information, please contact your local Sales Representative at [www.onsemi.com/support/sales](http://www.onsemi.com/support/sales)